

30W LED FLOOD LIGHTS

The LEDFL10-30 saves 50–70% on the electricity costs when compared with conventional lighting.

The LEDFL10-30PIR comes complete with an inbuilt sensor, perfect for use as a security light.

This model has a two year warranty.

FEATURES

- Instant start up
- Cool running temperature
- Vibration resistant
- Low energy costs
- Low maintenance costs
- No strobe effect
- Available with or without inbuilt sensor
- Long life span up to 30,000 hours

TECHNICAL SPECIFICATIONS

Total Power	30W
Supply Voltage	85 ~ 265V AC
Power Factor	0.98
Colour rendering index	Ra>80
Ambient temperature	-40°C to 50°C
Colour temperature	5700K
Weight	2kg
Dimensions	225 x 185 x 145mm
Lifespan	Up to 30,000 hours

CAT NO.	Lumens	Power	Current	IP Rating
LEDFL10-30AC	2663	30W	0.13A	IP65
LEDFL10-30PIR	2663	30W	0.13A	IP44

SDOC is available on our website

20 Neilpark Drive
 East Tamaki
 Auckland.
 NEW ZEALAND
phone: 64 9 272 5619



LEDFL10 Dimensions

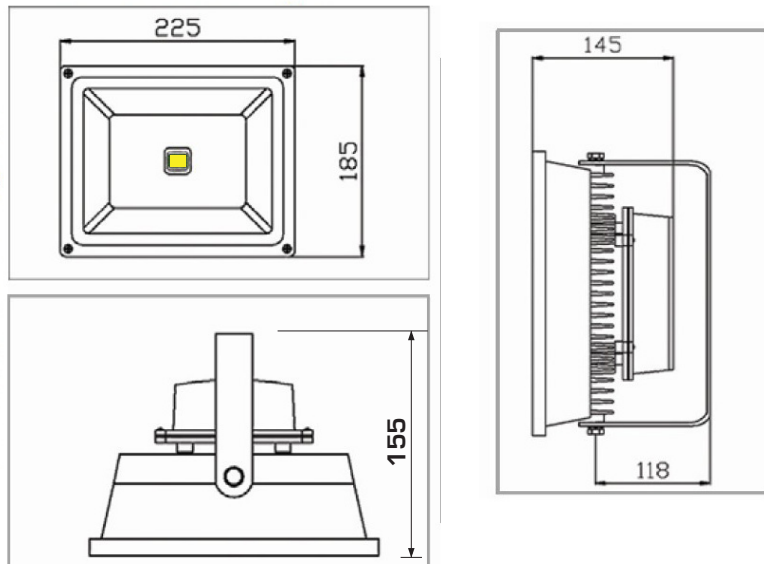

IDEAL FOR:

- Garages and workshops
- Security lights
- Path/walkway lighting